



RAZER BARRACUDA X CHROMA

MASTER GUIDE

Whether you're at home or on the go, experience true audio versatility and flair anywhere with the **Razer Barracuda X Chroma**. Featuring Razer SmartSwitch Dual Wireless, toggle between gaming and mobile use instantly with a lightweight wireless RGB gaming headset that offers the best of both worlds.

CONTENTS

1. WHAT'S INSIDE.....	3
2. WHAT'S NEEDED.....	5
3. LET'S GET YOU COVERED.....	5
4. TECHNICAL SPECIFICATIONS.....	6
5. GETTING STARTED	7
6. USING YOUR RAZER BARRACUDA X CHROMA.....	11
7. CONFIGURING YOUR RAZER HEADSET	16
8. SAFETY AND MAINTENANCE.....	30
9. LEGALESE	31

1. WHAT'S INSIDE

- Razer Barracuda X Chroma

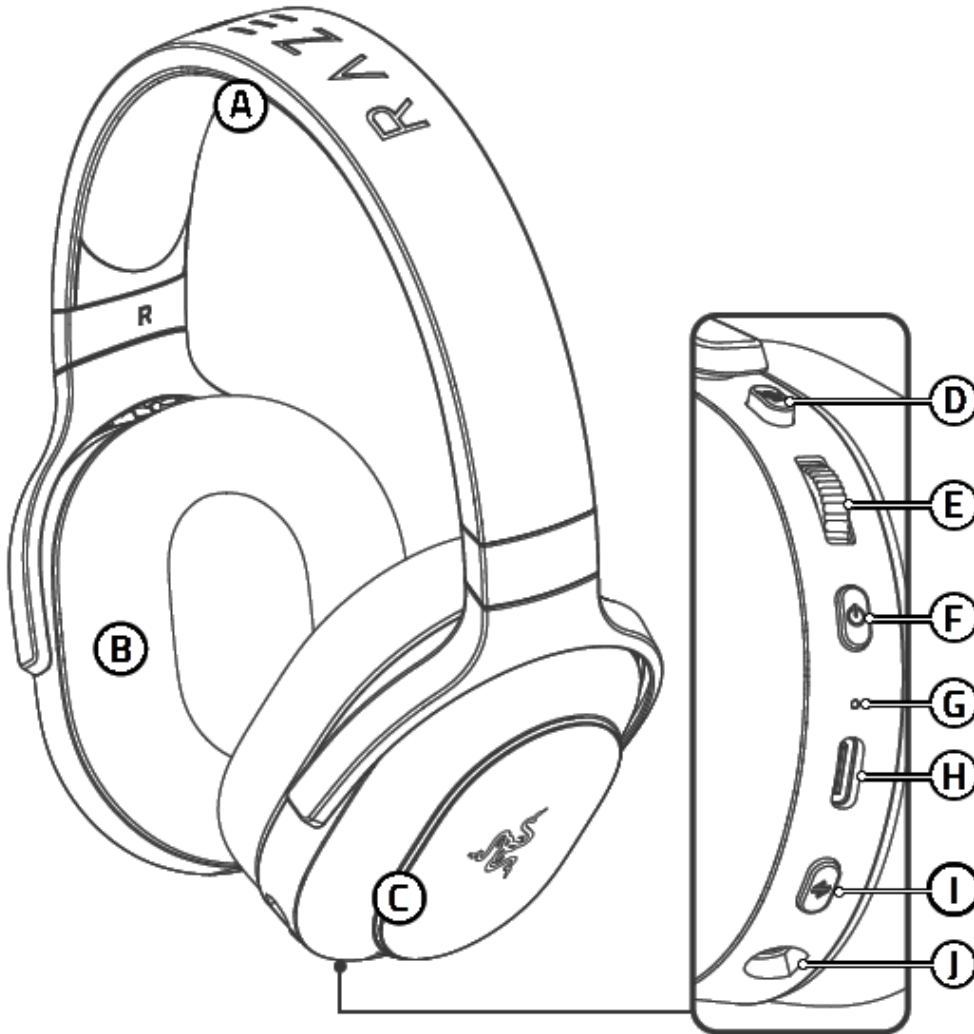

- A.** Adjustable padded headband
- B.** Breathable fabric with memory foam cushions
- C.** 6-Zone earcup lighting Powered by Razer Chroma™ RGB
- D.** Mic mute button
- E.** Volume dial
- F.** Power button
- G.** Status Indicator
- H.** USB Type C charging port
- I.** Razer™ Smartswitch Dual Wireless button
 - 2.4Ghz Mode
 - Bluetooth® Mode
- J.** Microphone jack

- USB Type C Razer™ HyperSpeed Wireless Dongle

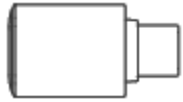

- Removable Razer™ HyperClear Cardioid Mic

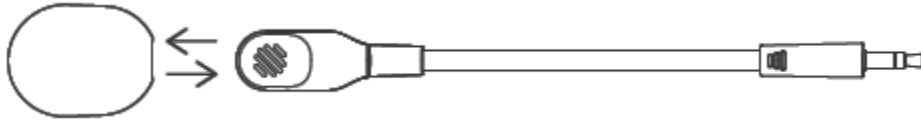

- USB Type C charging cable

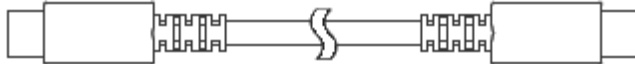

- Type C to Type A adapter

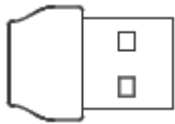

- Important Product Information Guide

2. WHAT'S NEEDED

PRODUCT REQUIREMENTS

- Devices with Bluetooth audio capability or USB Type C / Type A port

RAZER SYNAPSE REQUIREMENTS

- Windows 10 (or higher)
- Internet connection for app installation

RAZER AUDIO APP REQUIREMENTS

- iOS 12 / Android 8.1 Oreo (or higher)
- Internet connection for app installation

3. LET'S GET YOU COVERED

*Your product's serial number
can be found here.*

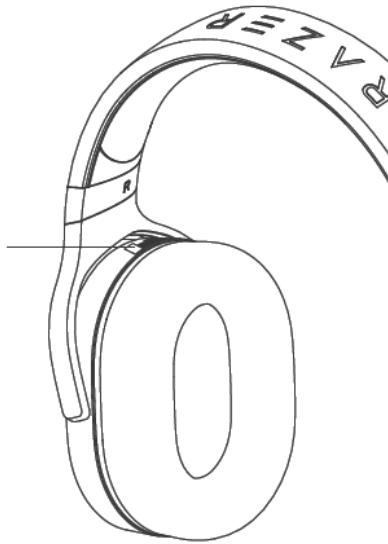

Register your product and score exclusive benefits
[razerid.razer.com/warranty](https://www.razerid.razer.com/warranty)

4. TECHNICAL SPECIFICATIONS

FEATURES

Headphones

- Frequency response: 20 Hz – 20 kHz
- Impedance: 32 Ω @ 1 kHz
- Sensitivity: 96dB SPL/mW@1kHz by HATS
- Drivers: Customized Dynamic 40mm Driver
- Inner ear cup diameter: 60 x 40mm
- Connection type: 2.4 GHz Wireless / Bluetooth
- Approx. weight: 285g / 0.635lbs
- Oval ear cushions: Breathable Fabric with Memory Foam Cushions

Microphone

- Frequency response: 100 Hz – 10 kHz
- Signal-to-noise ratio: \geq 60 dB
- Sensitivity (@1 kHz): -42 ± 3 dB
- Pick-up pattern: Unidirectional

On-earcup controls

- Power Button
- Volume Dial
- Mic Mute Button
- Razer SmartSwitch Button

Audio Usage

- Wireless: 2.4GHz Wireless via USB Type C dongle or Bluetooth 5.3
- Bluetooth Codec: SBC
- 7.1 Surround sound: Only available on Windows 10 64-bit (or higher)

Battery Life

- Up to 70 hours (Lighting OFF, 2.4GHz connection)
- Up to 35 hours (Lighting ON, 2.4GHz connection)

5. GETTING STARTED

CHARGE YOUR HEADSET

1

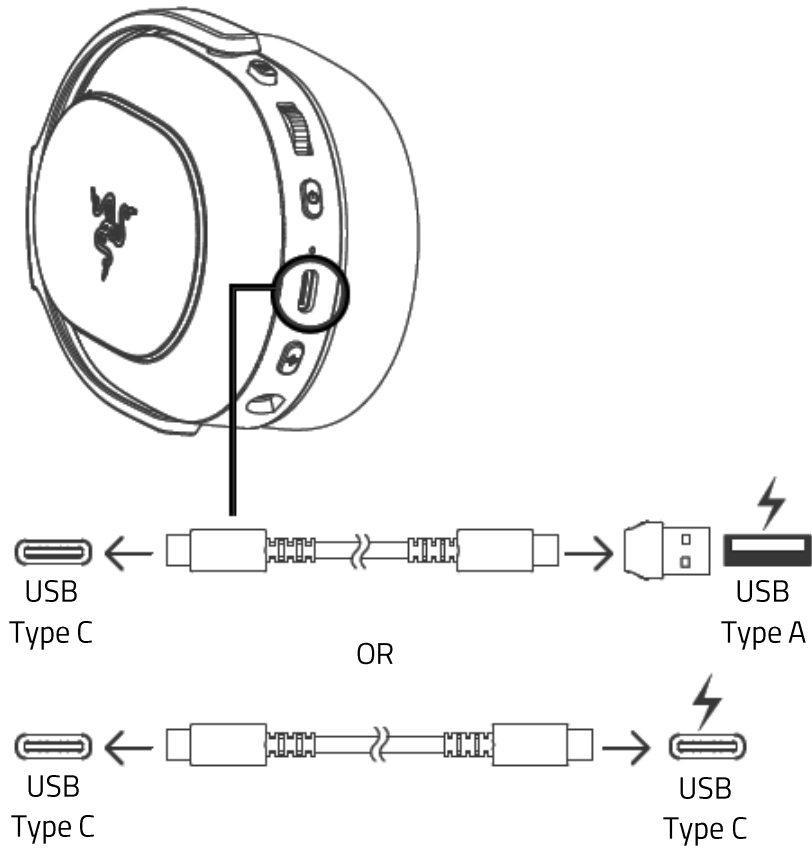

2

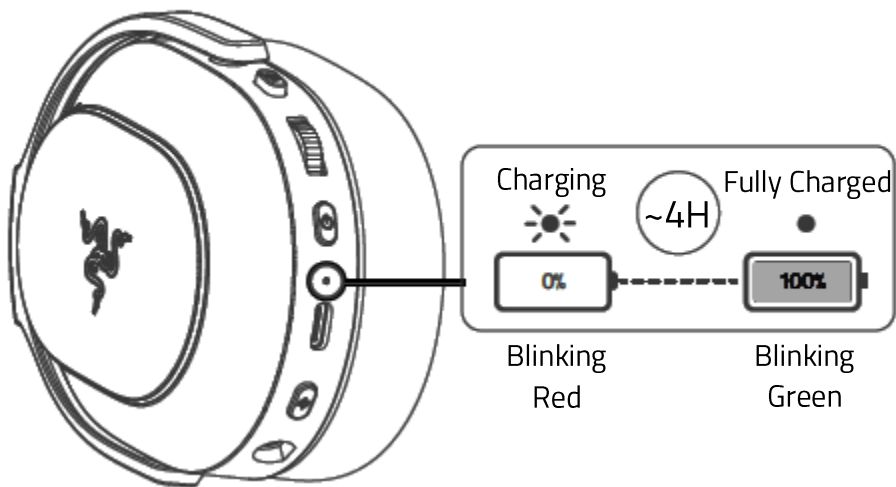



For best results, connect your Razer Barracuda X Chroma directly to your computer's USB port using the provided cable.

POWER YOUR HEADSET ON/OFF

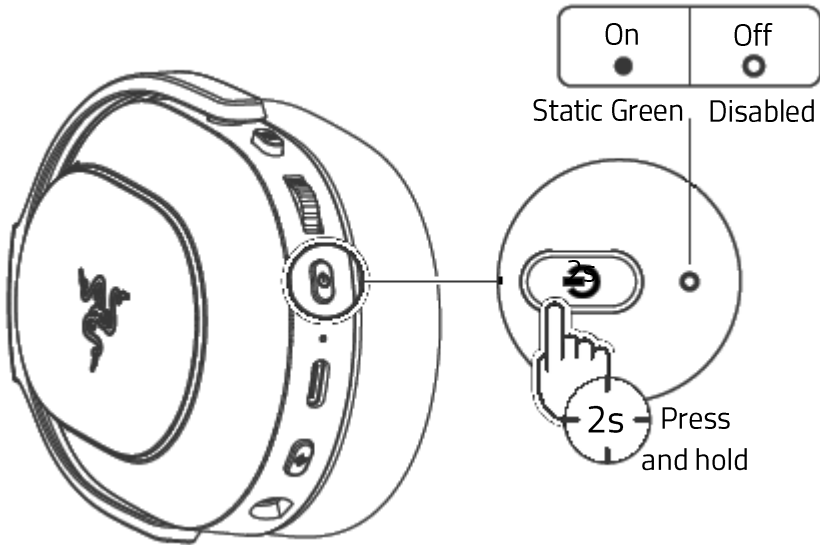

CONNECT TO YOUR DEVICE

2.4GHZ MODE

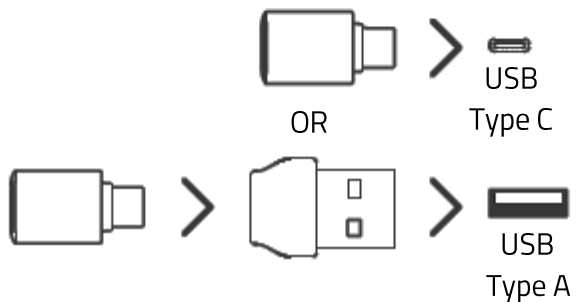
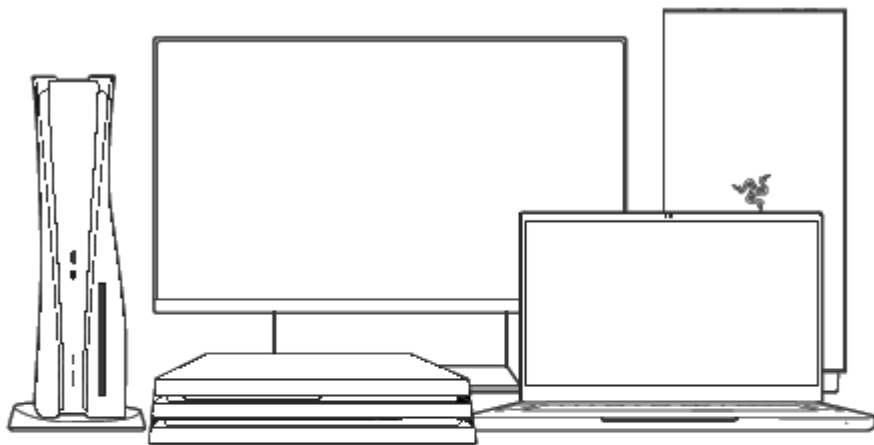

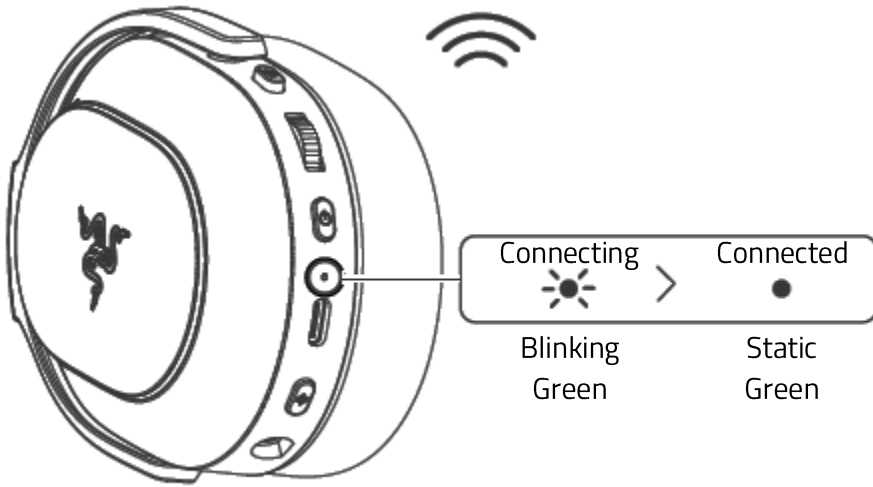

i Install Razer Synapse when prompted or download the installer from razer.com/synapse.

Set Up For PC

When using your headset with a compatible device, set Razer Barracuda X Chroma as its default input and output device. Also, download Razer Synapse to unlock the full feature set of your device.

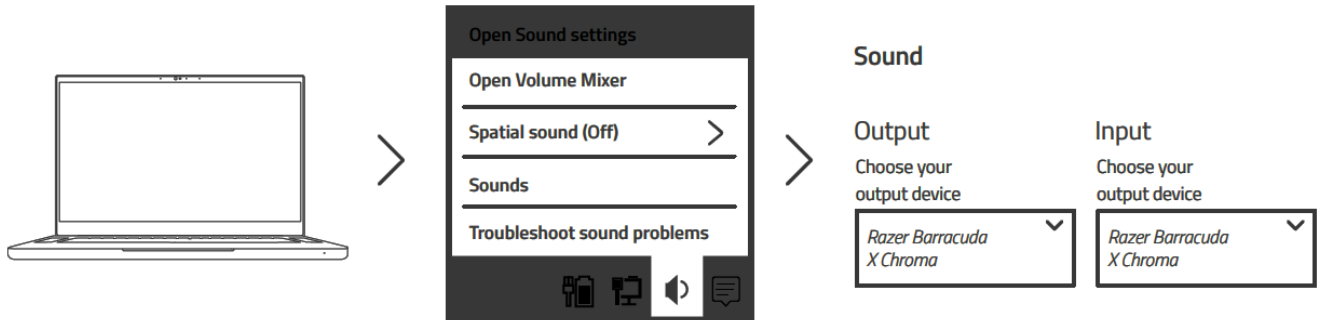

Activate 7.1 Surround Sound*

Experience accurate positional sound that's specifically designed for games, movies, and music.

1. Download the 7.1 Surround Sound software from razer.com/7.1-surround-sound
2. Register your product at razerid.razer.com/products to get your activation code sent to your email.

**Only available on Windows 10 64-bit (or higher)*

BLUETOOTH® MODE

1

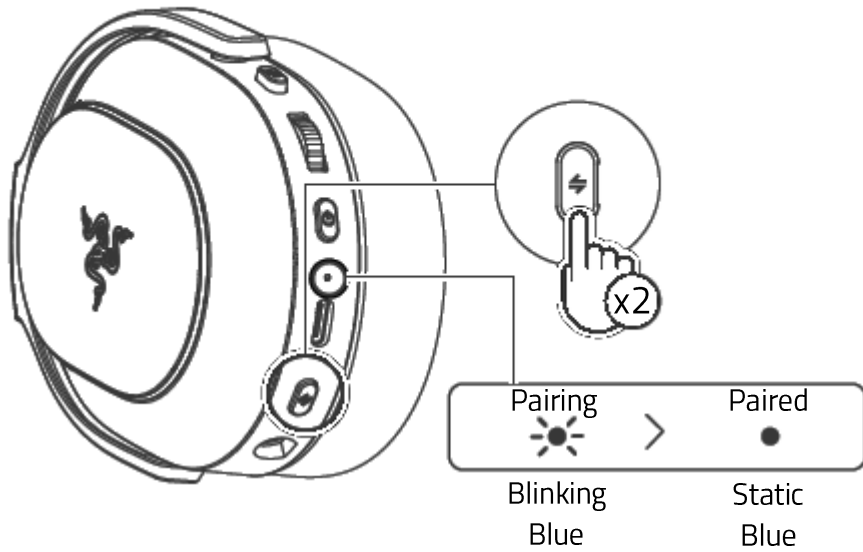

2

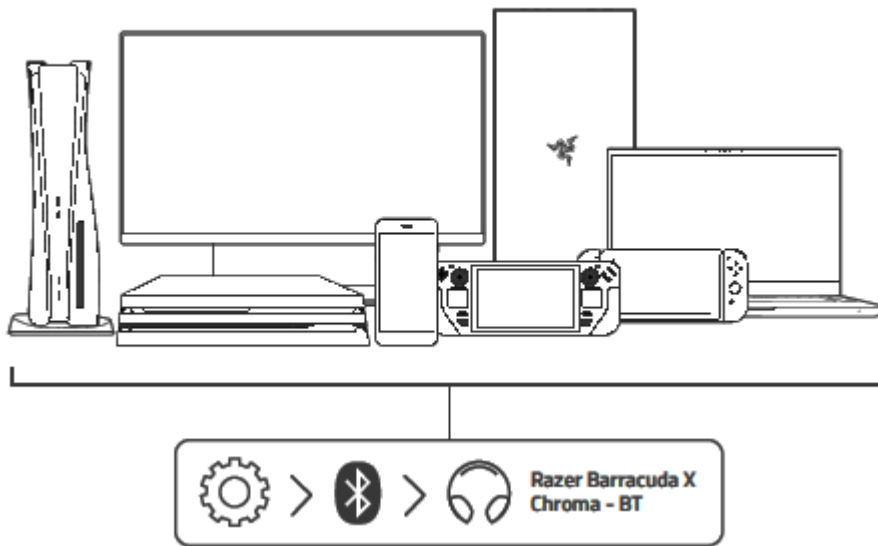

** If pairing times out, power on the headset and use the re-pairing step to reactivate pairing.*

Re-Pairing Your Headset

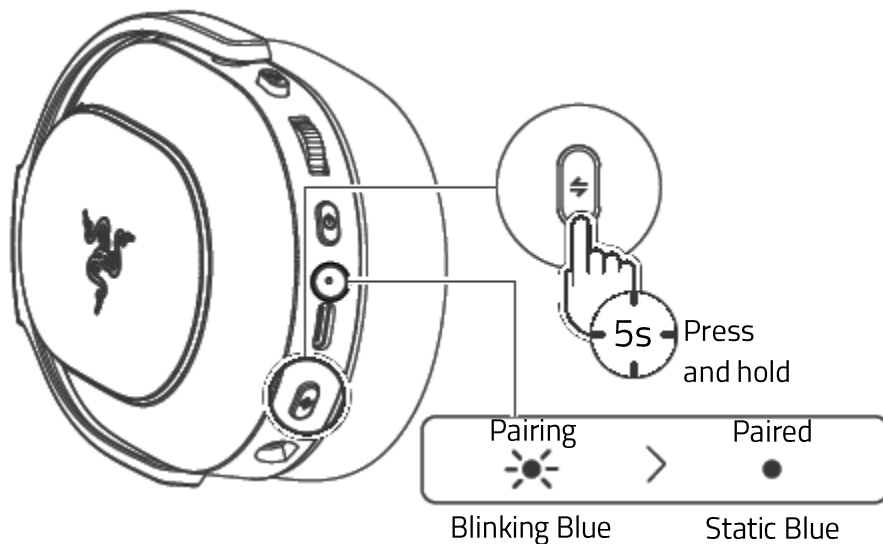

Set Up For Mobile

Download the Razer Audio App to customize your headset's EQ settings, auto shutoff feature, gaming mode, and much more — anytime, anywhere.



Razer Audio



OR

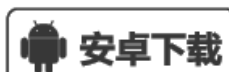

RZR.TO/AUDAPP
(For China only)

i When using the Razer Audio app, make sure that the headset is only connected to your mobile device via Bluetooth.

PAIRED TO BOTH MODES

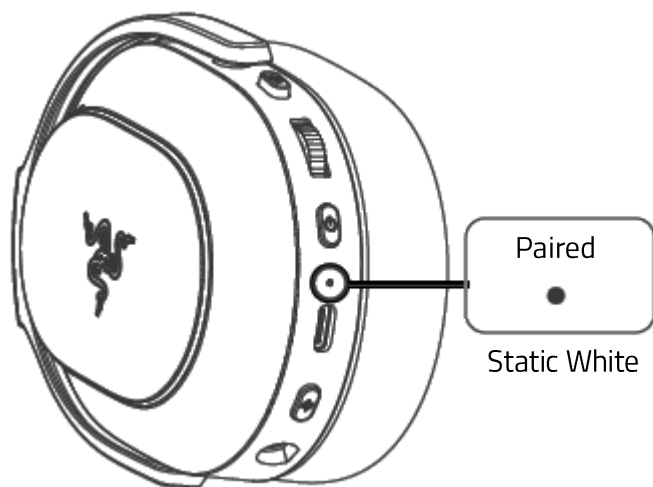

6. USING YOUR RAZER BARRACUDA X CHROMA

RAZER HYPERCLEAR CARDIOID MIC

PLUG IN THE MIC

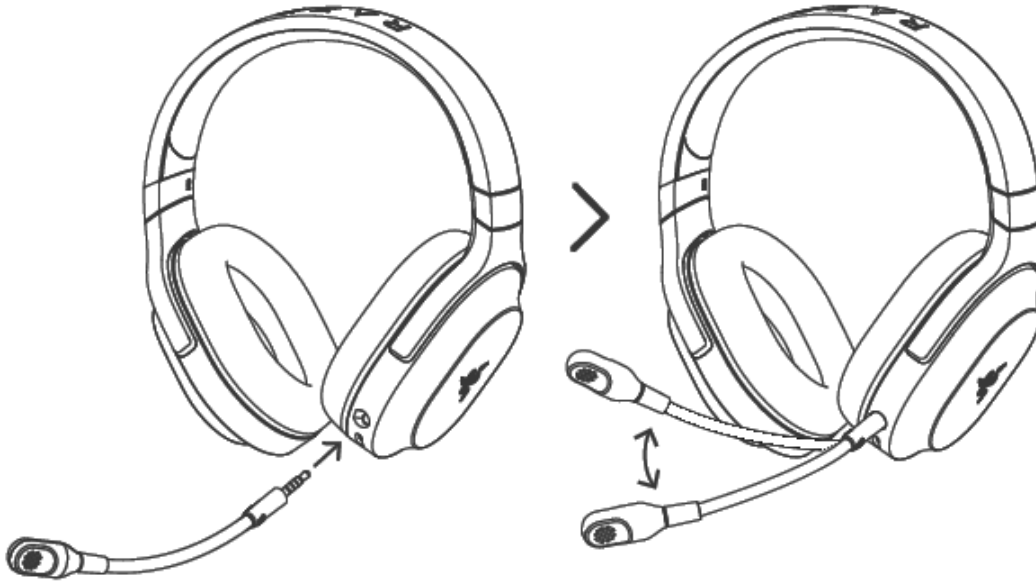

PROPER MIC PLACEMENT

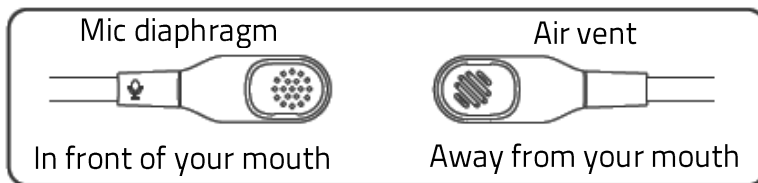
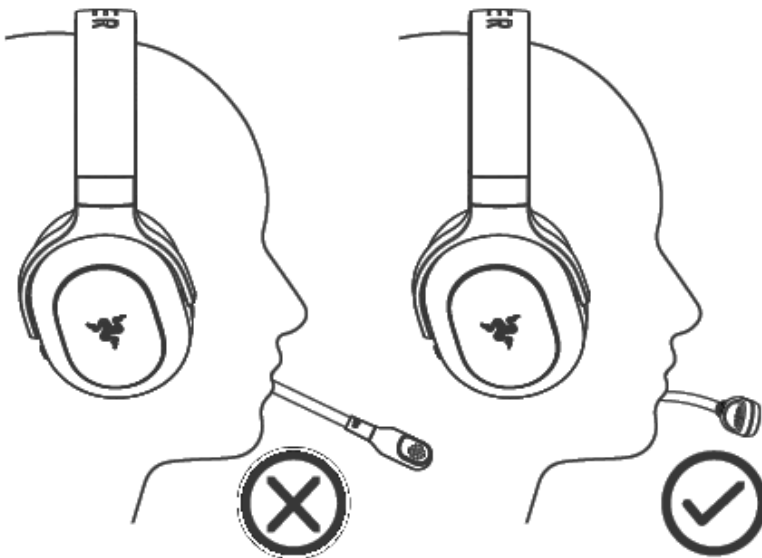

SET THE MIC TO MUTE/UNMUTE

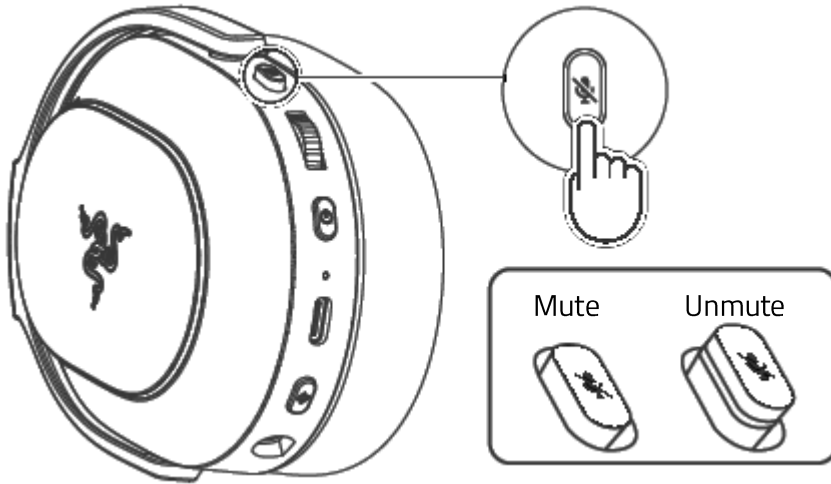

SWITCH BETWEEN WIRELESS MODES

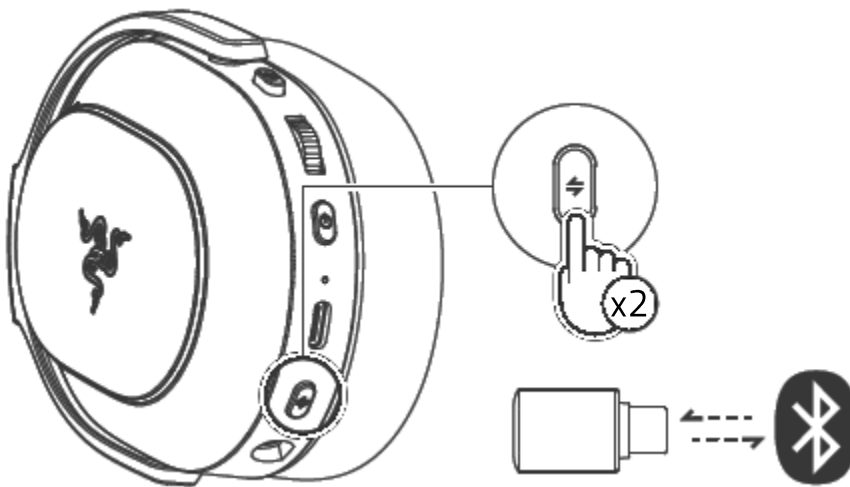

i To use the SmartSwitch function, the headset must be connected to both wireless modes.

TURN THE VOLUME CONTROLS

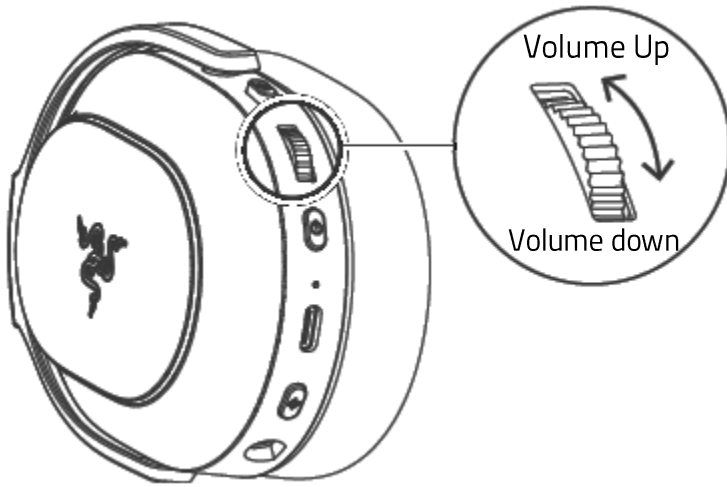

CHECK THE BATTERY STATUS

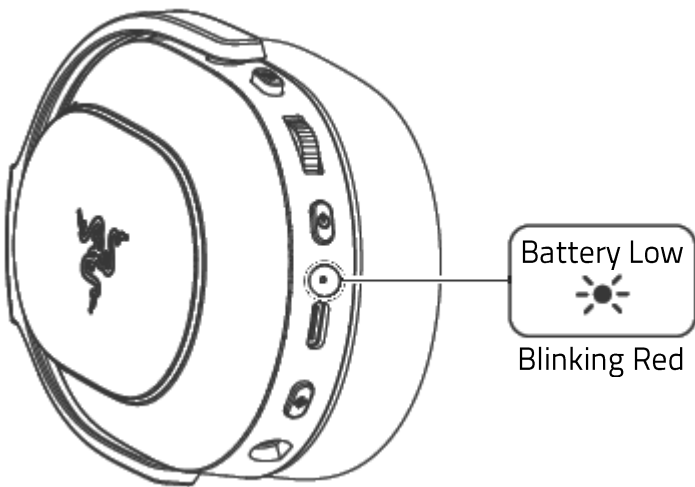

CHROMA ON/OFF

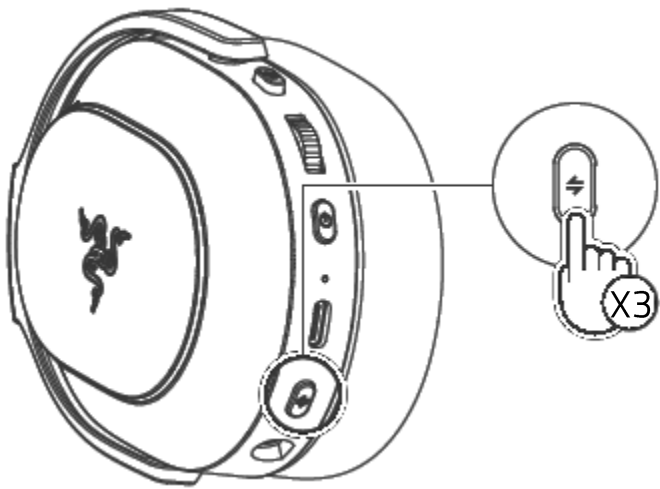

ADJUST FOR COMFORT

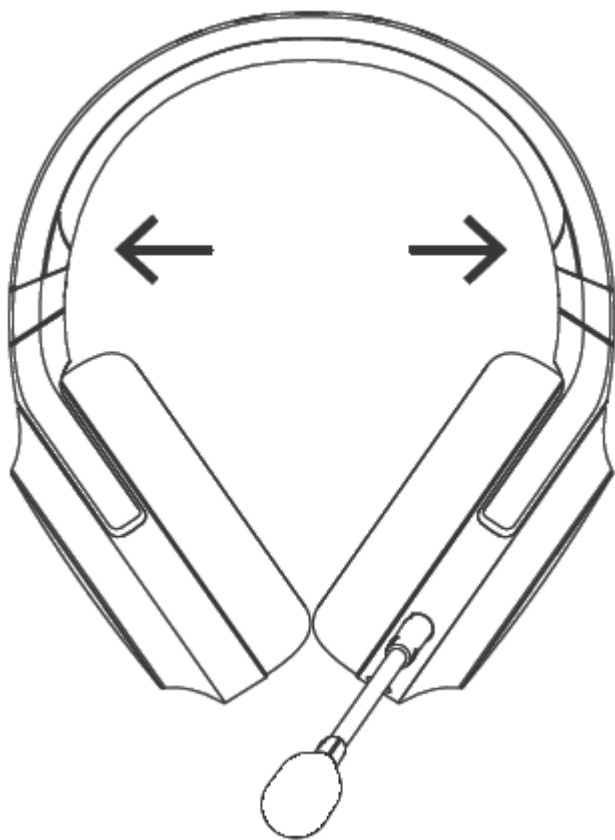

i Gently stretch the headbands before wearing the headset but do not overstretch it to avoid permanent damage.

Find out more about your gaming-grade headset at support.razer.com

7. CONFIGURING YOUR RAZER HEADSET

i *Disclaimer: This guide provides an overview of the New Razer Synapse app and may only partially cover some of the features of your device. The New Razer Synapse requires an Internet connection to install, update, access, and save cloud-based features. Registering for a Razer ID account is recommended but optional. All features listed here are subject to change based on the current version, connected device(s), and supported add-ons.*

SYNAPSE

The Synapse tab is your default tab when you first launch Razer Synapse. Use the following buttons below to navigate the user interface:

– Minimize

Clicking this button will minimize the app to the taskbar while it runs in the background.

▢ Maximize

This button expands the browser window to fill the entire screen. To restore the window to its original size, click the maximize button again.

× Close

This button will close all relevant tabs and terminate the application completely.

< Previous Tab

Clicking this button will return you to the last tab you have visited.

> Next Tab

Clicking this button will move you to the next page if you've recently used the Previous Tab button.

↻ Refresh Tab

This button reloads the current page. Use this if a page isn't displaying correctly or you want to see the latest content.

↓ Download Update

If this button appears, that means there are changes to the app. Use this if a page isn't displaying correctly or you want to see the latest content.

More

Clicking this button will open a pop-up so you can easily access your Devices, Modules, and Other Installed Apps tabs.

Settings

Clicking this button will open the Settings tab, so you can quickly change the settings to this app.

Profile

This button will open a pop-up to access the Log In, Feedback, Rate This Software, Add WiFi Device, and Exit options.

Info

Hovering over this button will pop up an additional information about a feature or function.

Dashboard

The Dashboard subtab is an overview of your Razer Synapse, where you can access all your Razer devices, modules, and online services.

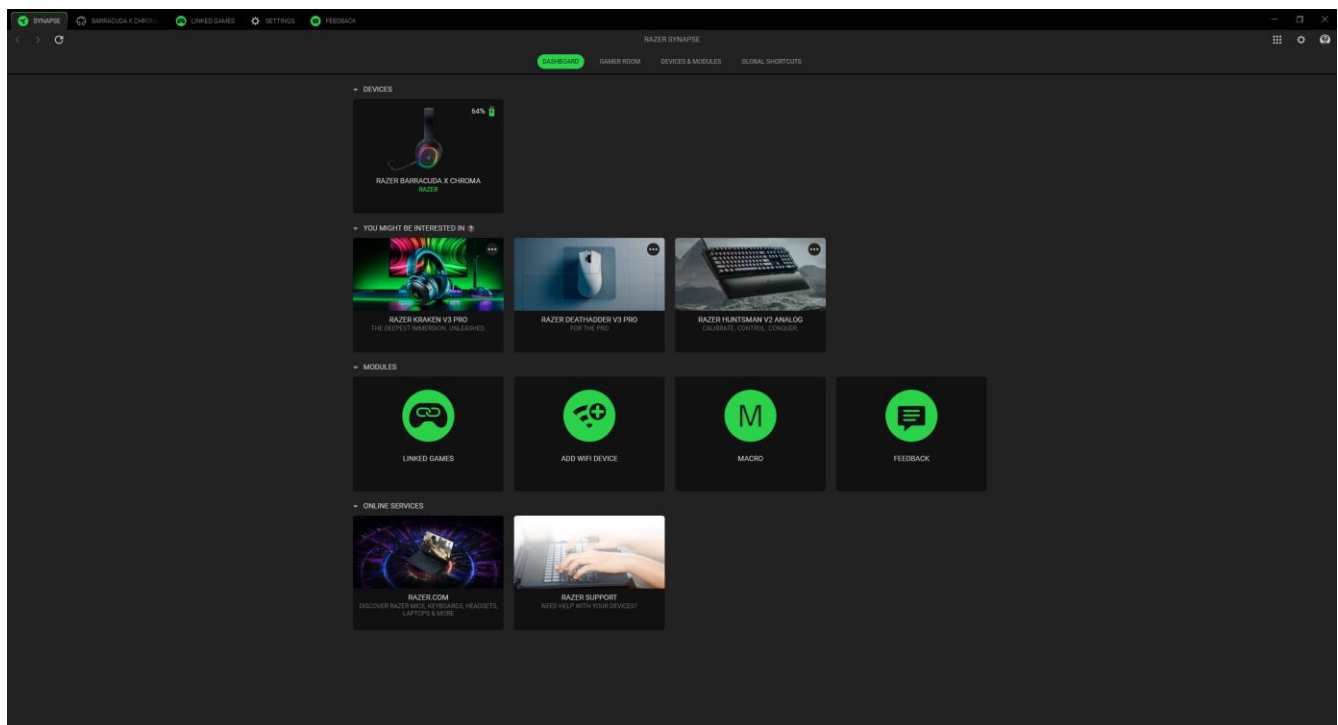

Gamer Room

The Gamer Room subtab shows all devices with the Razer Aether Light feature. From here, you can view and manage your Gamer Room-supported devices.

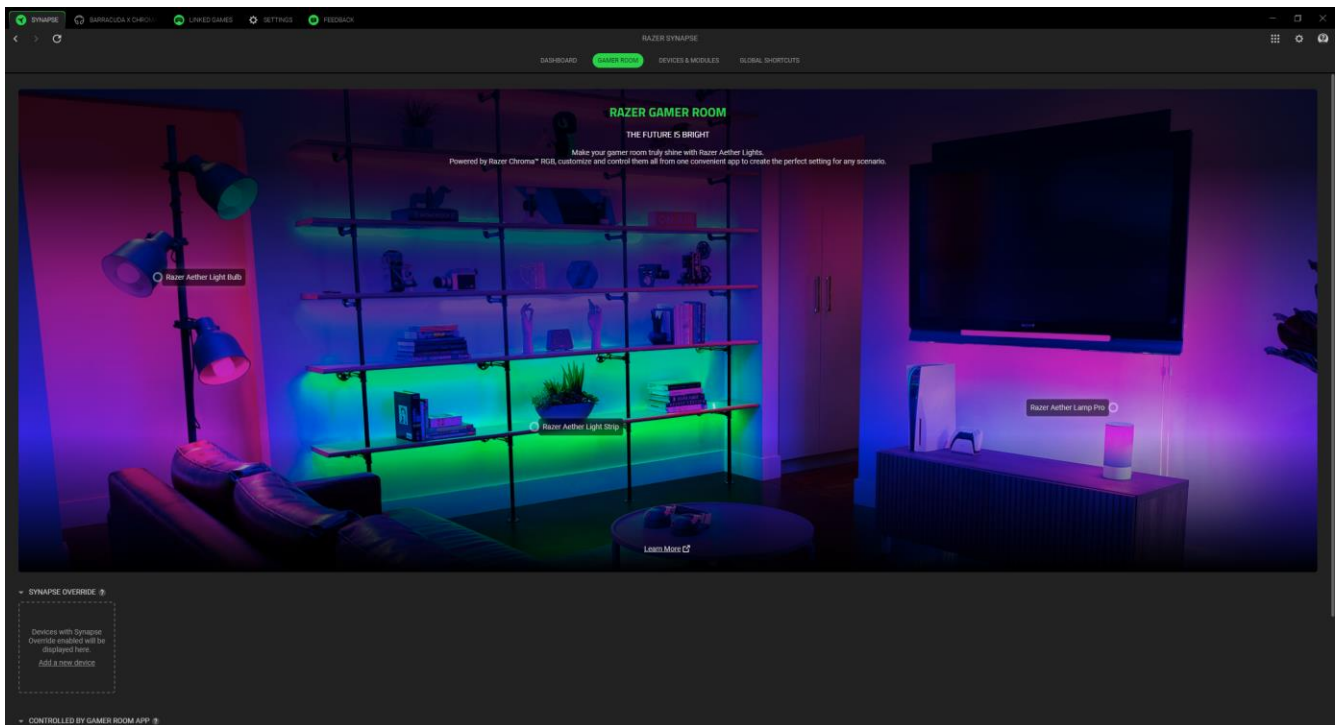

Synapse Override

This section allows you to select and customize your device's lighting and make it react to Chroma-enabled games and Chroma Connect apps using Razer Synapse.

Controlled By Gamer Room App

This section displays all supported devices controlled remotely by the Gamer Room app.

Devices & Modules

The Modules subtab displays all installed and available modules for installation.

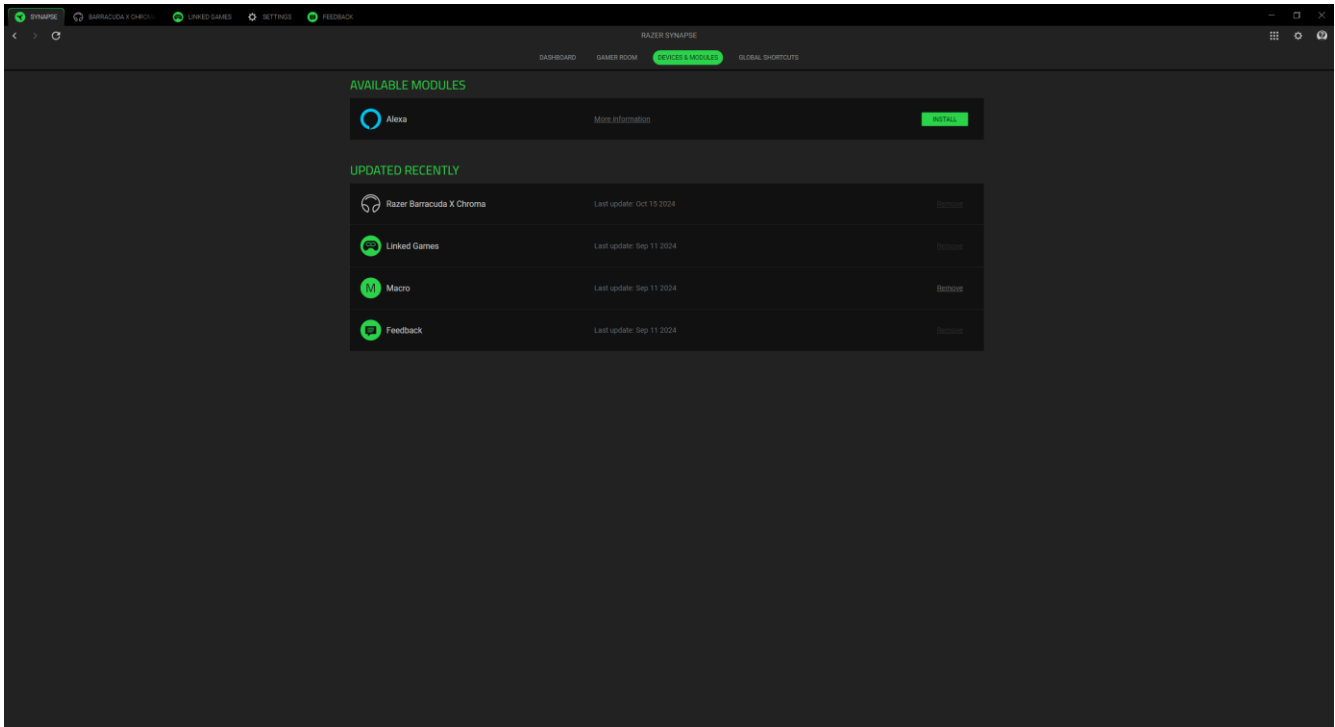

Global Shortcuts

Bind operations or Razer Synapse functions to custom key-combinations from any Razer Synapse-enabled device inputs, which apply across all device profiles.

 *Only Razer Synapse-enabled device inputs will be recognized.*

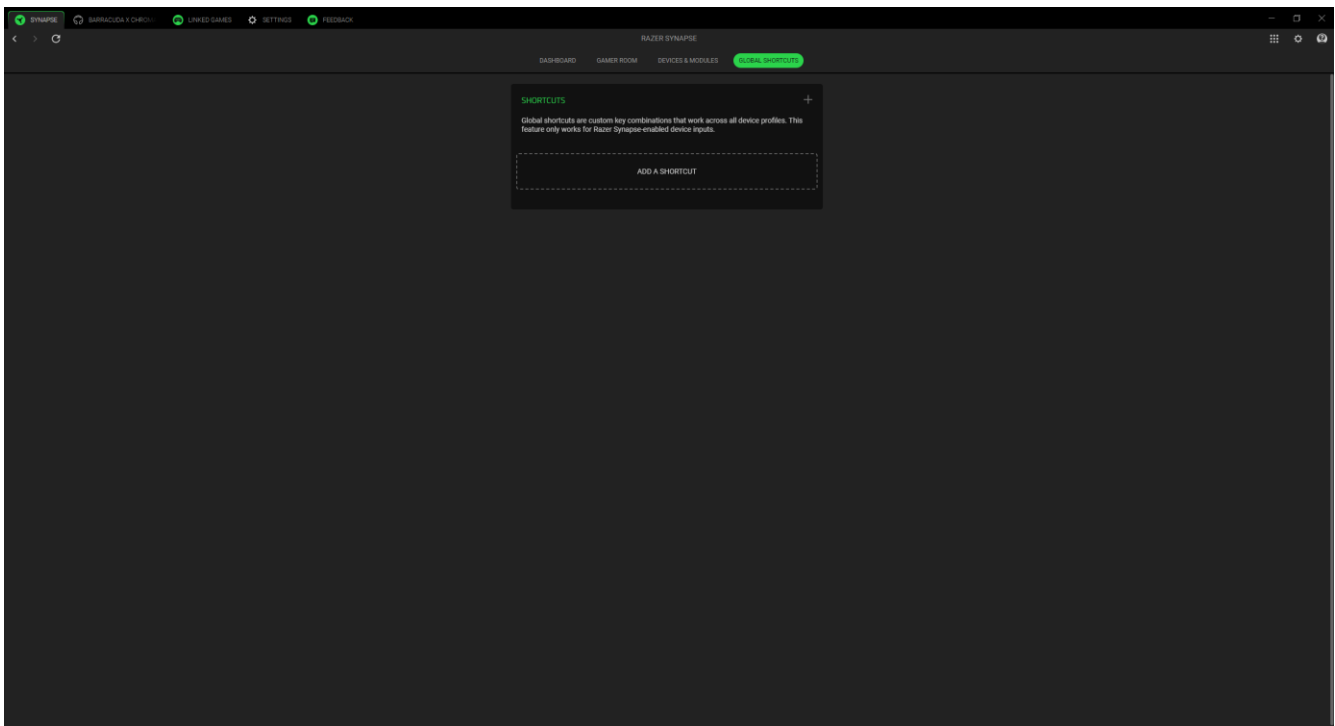

BARRACUDA X CHROMA

The Barracuda X Chroma tab is the main tab for your Razer headset. You can change your device settings from here, such as lighting (if supported), setting and customizing EQ profiles, and adjusting the overall system volume or individual volume of all active applications. Any changes under this tab will be saved automatically to your local system and cloud storage. Use the following buttons below to access your profile options:

▾ Profiles Dropdown Bar

Clicking this dropdown bar will display all the profiles for this device so you can quickly change profiles.

⋮ Miscellaneous

Clicking this button will open a pop-up with options related to your current profile.

Sound

The Sound subtab is for adjusting and modifying your device's audio settings.

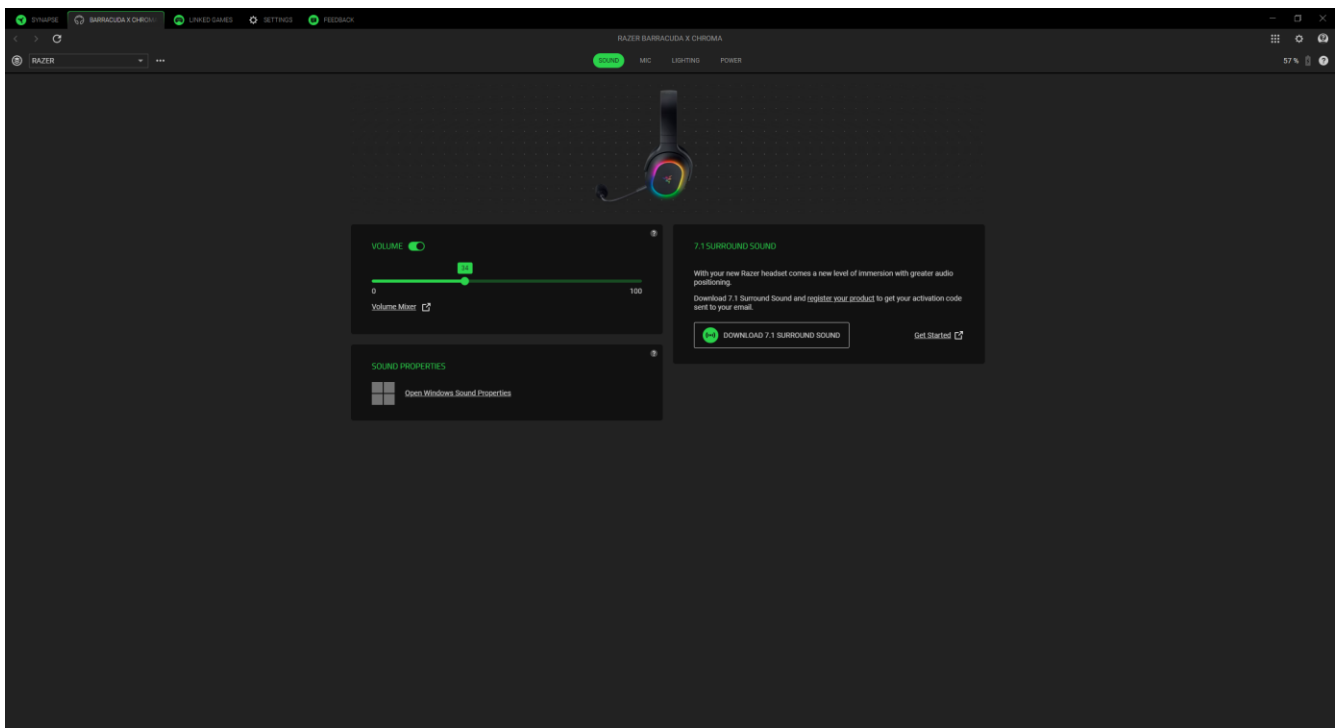

Profile

Profile is a data storage system that keeps all your Razer device settings. By default, the profile name is based on your system's name. Clicking the dropdown bar (▾) will display all profiles for this device so you can quickly switch between them. To add, import, rename, duplicate, export, or delete a profile, press the profile's corresponding Miscellaneous button (⋮).

Volume

Adjust the audio volume of the device. You can also adjust the system's overall volume or individual application volumes using the Windows volume mixer.

Sound Properties

Launch the Windows Sound Properties window to manage system sound settings, such as playback and recording device configurations, sound schemes, and default communications activity.

7.1 Surround Sound

The following functions are only available for devices that come with THX Spatial Audio: [Learn which devices include 7.1 Surround Sound](#)

Mic

The Mic subtab enables you to change all outgoing mic audio settings.

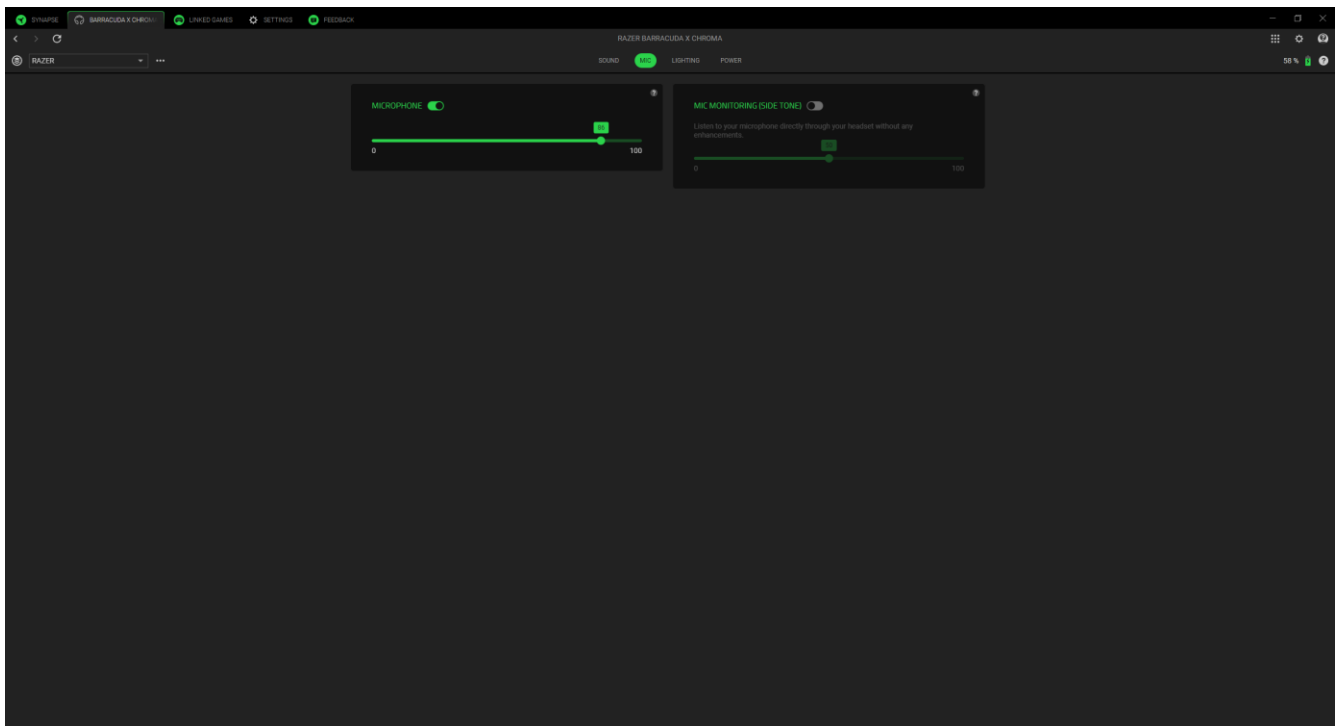

Microphone

Adjust the microphone volume or disable it by using the toggle. You can also activate the **Mic Preview** to test the microphone's input audio intensity.

Mic Monitoring (Side tone)

Toggle this setting to monitor your microphone's sound directly via the headset, adjusting the monitoring volume as desired.

Lighting

The Lighting subtab enables you to modify your Razer device's light settings.

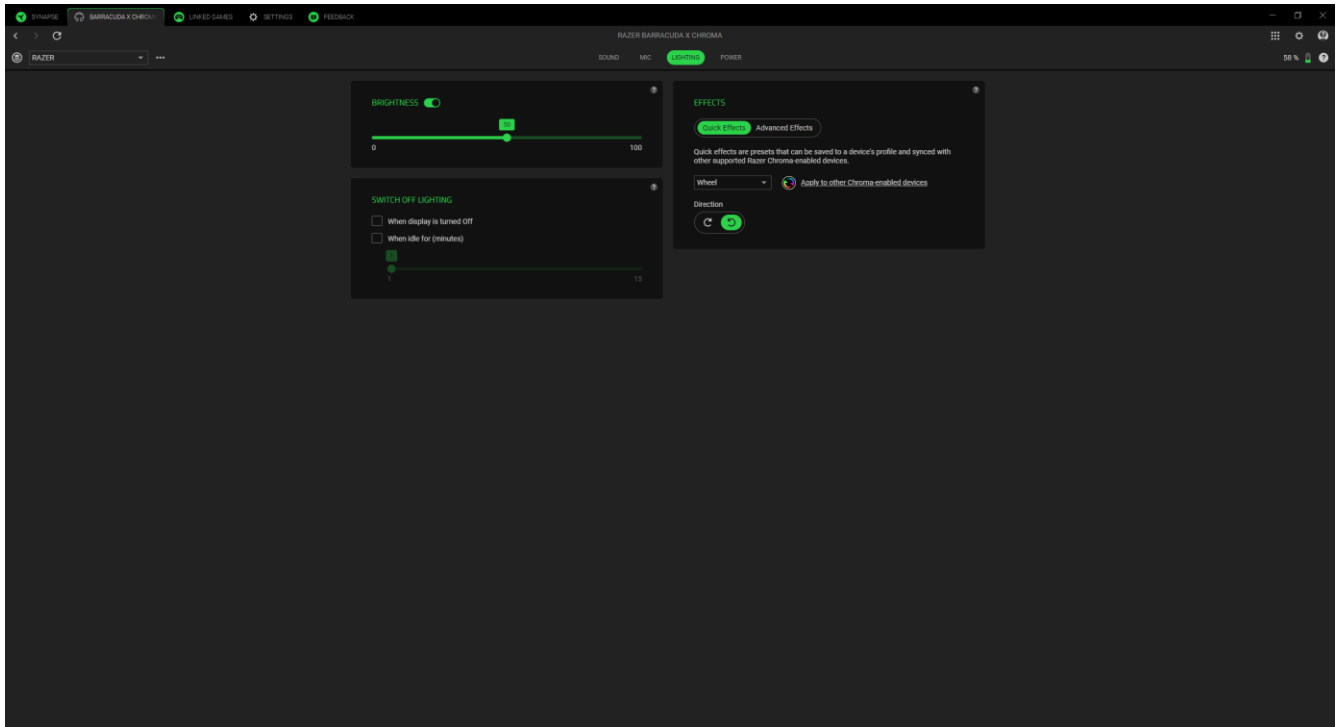

Brightness



You can turn off your Razer device's lighting by toggling the Brightness option or increase/decrease the luminance using the slider.







Switch Off Lighting

This power-saving tool allows you to disable your device's lighting when your system's display turns off or automatically power it down after a period of inactivity.

Quick Effects

A number of quick effects can be selected and applied to your device's lighting, as listed here:

	Name	Description	How to set up
	Ambient awareness	The lighting on the headset will reflect the averaged color on the selected screen region.	Select or customize a screen region
	Audio meter	The headset will light up according to the audio level with a default spectrum of colors.	Select a Color Boost level.

	Breathing	The lighting will fade in and out of the selected color(s).	Select up to 2 colors or randomize colors
	Fire	The headset will light up in warm colors to mimic the motion of flames.	No further customization required
	Spectrum cycling	The lighting will cycle between 16.8 million colors indefinitely.	No further customization required
	Starlight	The headset will have a chance of fading in and out at a random time and duration.	Select up to 2 colors or randomize colors and select a duration.
	Static	The headset will remain lit in the selected color.	Select a color.
	Wheel	The lighting will rotate in the direction selected with a default spectrum of colors.	Select a direction.

If you have other supported Razer Chroma-enabled devices, you can synchronize their quick effects with your Razer device by clicking the Chroma Sync button ().

Advanced Effects

The Advanced Effects option allows you to choose a Chroma Effect Profile you want to use on your Razer Chroma-enabled peripheral. To start making your own Chroma Effect Profile, press the

Launch Chroma Studio button ().

 *Some lighting effects listed here may not be available for your device. Only other Razer devices that support the selected lighting effect will synchronize. Indicator LEDs are not customizable.*

Power

For wireless devices, the Power subtab allows you to manage your device's energy consumption when running on batteries.

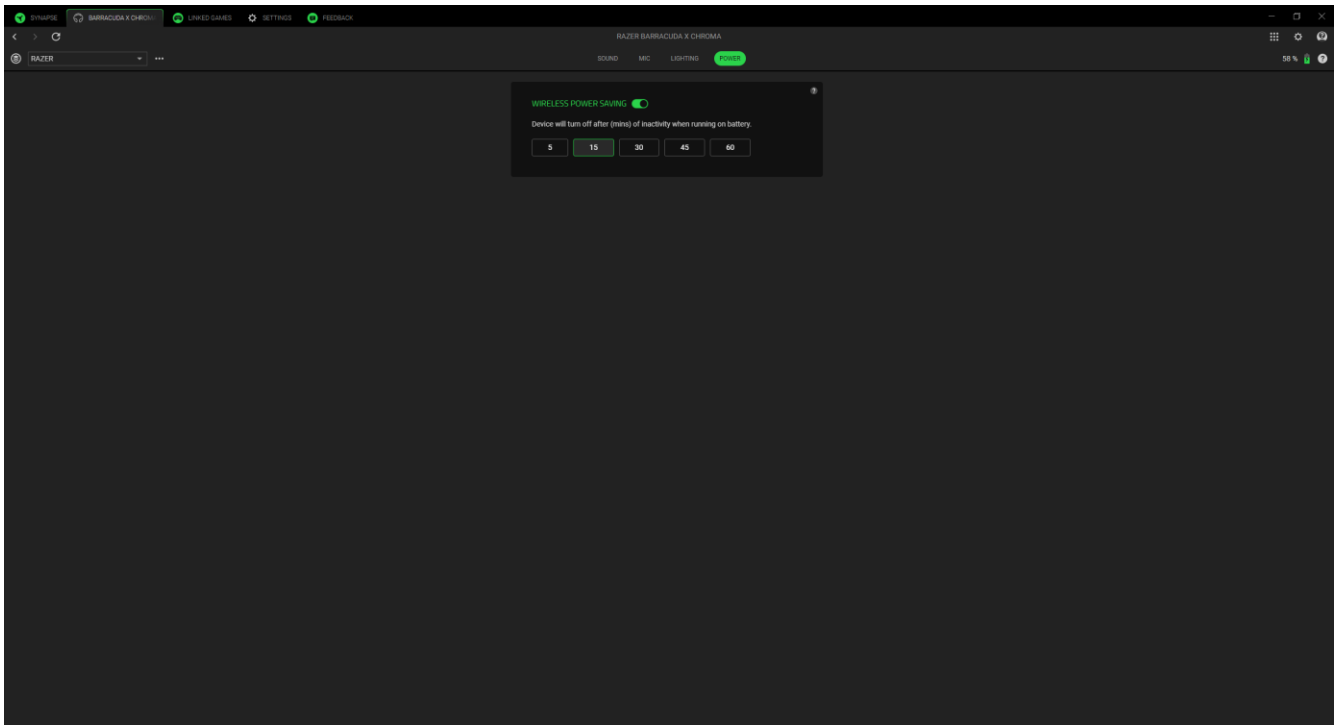

Wireless Power Saving

Set the device to power off when it has been idle for a certain amount of time.

LINKED GAMES

The Linked Games tab allows you to add apps, view peripherals linked to apps, or search for listed apps.

Games

The Games subtab enables you to link apps to your peripherals. You can also sort apps based on alphabetical order, last played, or most played. Apps will still be listed here, even if not linked to a Razer device. To add an app that is not listed on the screen, you can use the Add button (+) to search for it manually or use the Scan button (🔍) to search for it automatically. Click the Search button (🔍) to look for a specific game or program from the list.

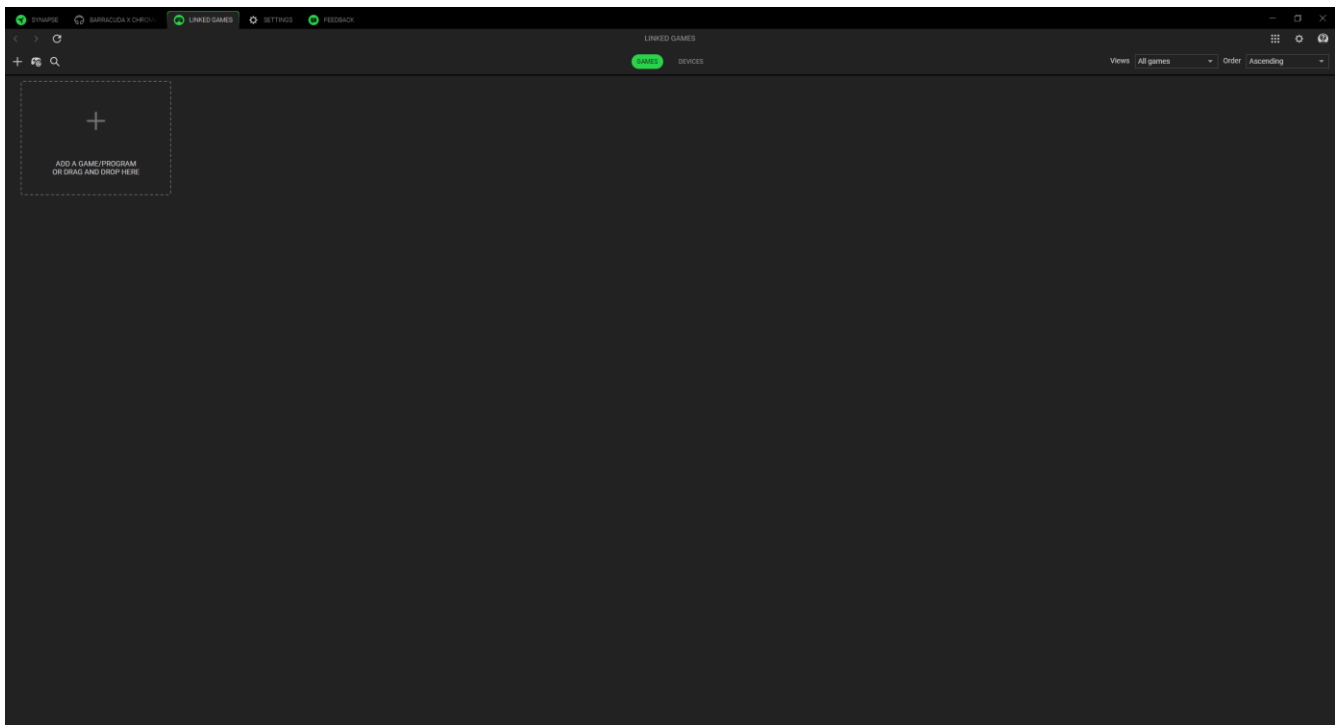

To link an app to your Razer device, click on it from the list and select a device and its profile. This will automatically set your device to the selected profile whenever you launch the app.

Devices

The Devices subtab lets you view your peripherals and determine which apps are linked to them. By selecting a device, you can see a list of linked apps, add new apps, or remove linked apps. You can filter these apps by using the Views and Order dropdown list. To add an app not listed on your peripheral, you can drag and drop the executable file inside the box or use the Add button (+) to open the search window. While inside the search window, you can click the Refresh button (↻) to rescan installed apps, the Search button (🔍) to look for a specific game or program from the list, or the Browse link to search for the app manually.

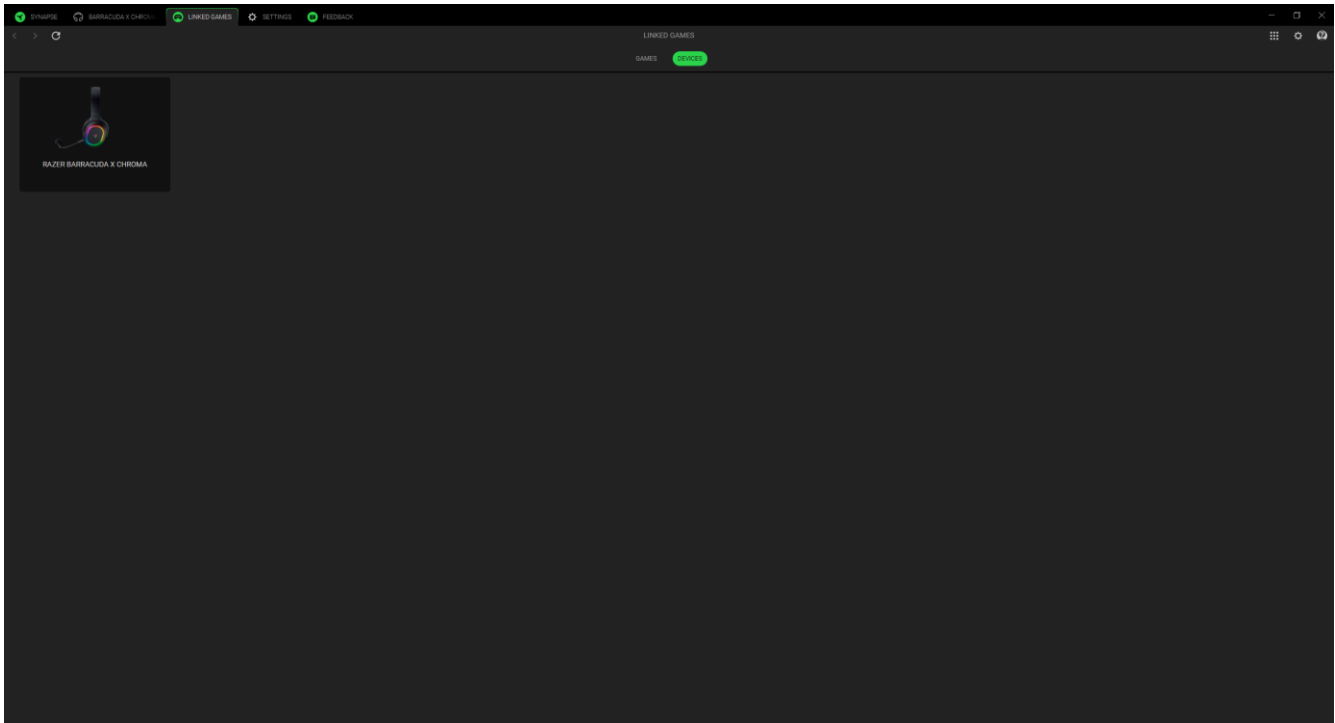

To link an app to your Razer device, click the tick box at the top left corner of the app while inside the search box. This will automatically set your device to the selected profile whenever you launch the app.

SETTINGS

The Settings tab, accessible by clicking the (⚙) button, enables you to configure numerous options as listed below:

Synapse

The Synapse subtab is where you can find options that are specific to the app.

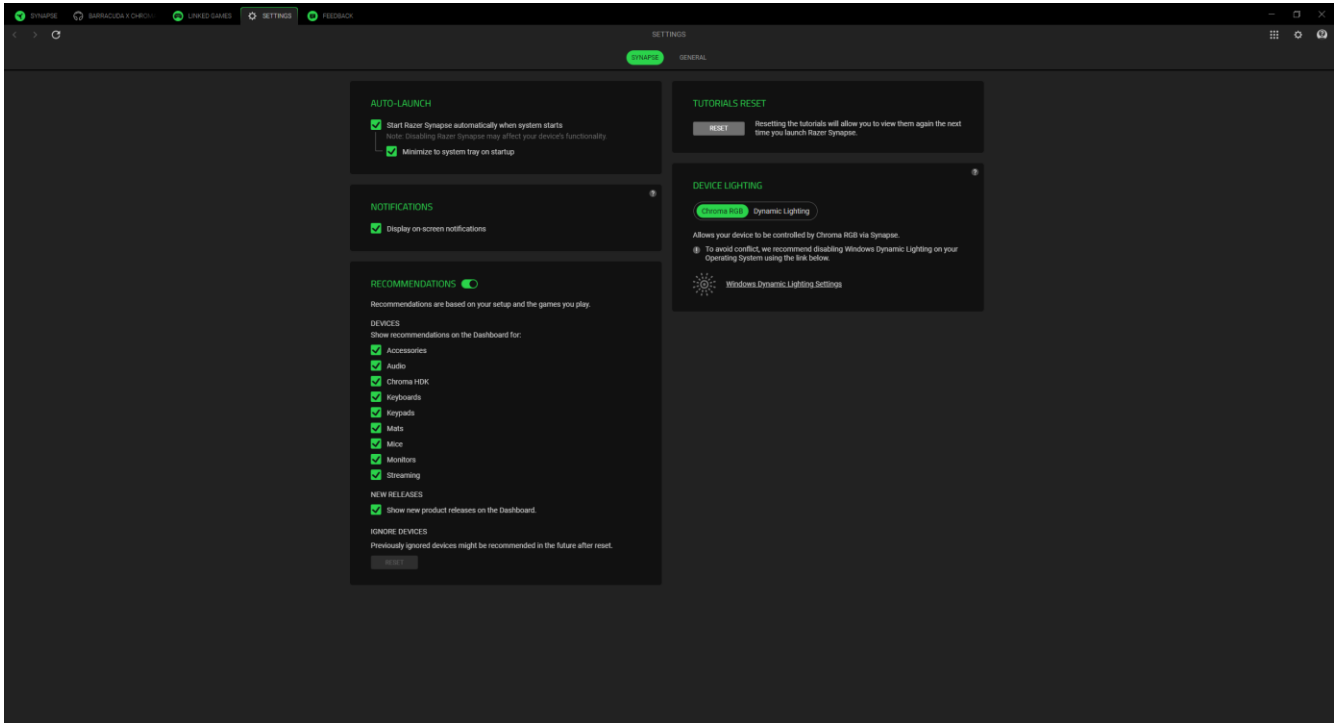

Auto Launch

The Auto Launch option allows you to configure the startup behavior the app.

Notifications

The Notifications option allows the app to display on-screen notifications even if you run full-screen apps.

Recommendations

Recommendations enable us to show the latest products and features on your Dashboard based on your installed devices and linked games.

Tutorials Reset

Selecting the Reset button will reactivate all tutorials that help you acquaint yourself with Razer Synapse's features.

Profile Migration

This function lets you transfer all your device's Profiles, Macros, and Chroma Effects from Synapse 3 to the new Synapse.

Device Lighting

This option lets you choose which app will control the lighting effects on your device.

General

The General subtab is the section where you can access miscellaneous options for your app, as well as find additional information about the software.

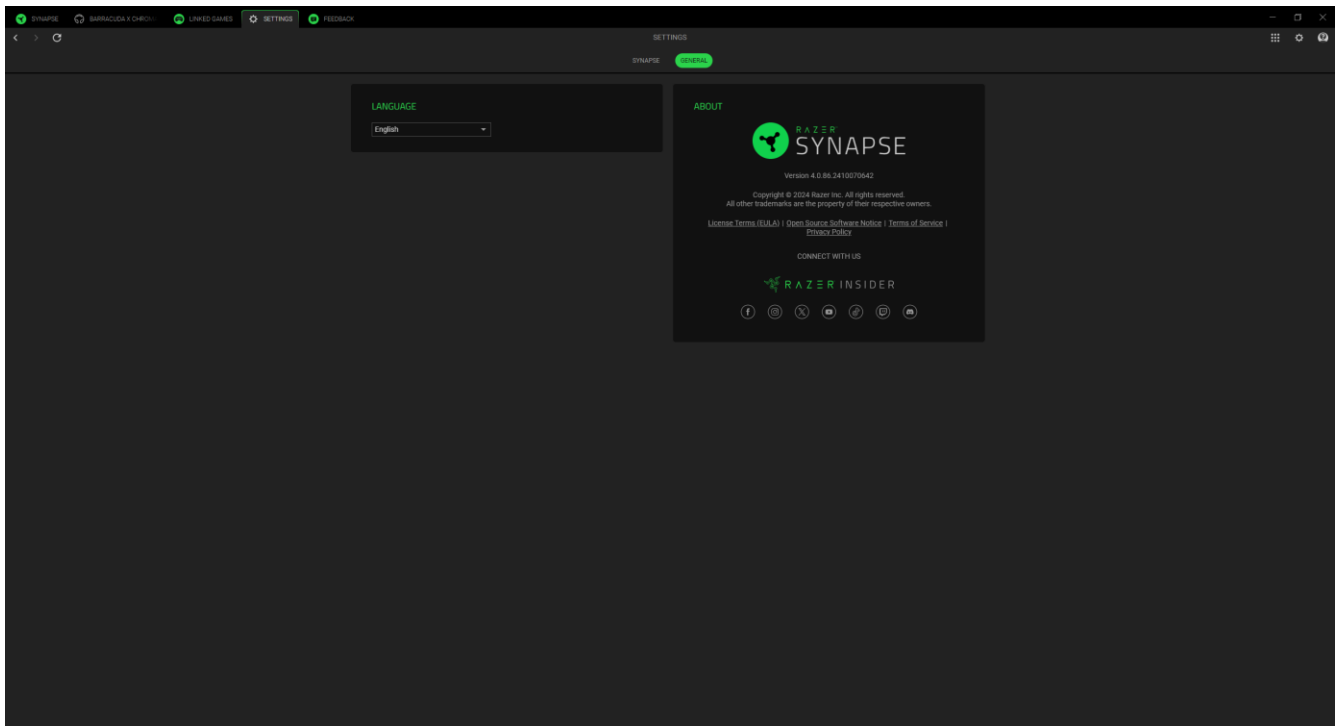

Language

This option lets you change the display language of Razer Synapse.

About

The About section shows the current software version, displays the copyright statement, and provides relevant links for Razer's terms of use. You may also use this option to access Razer's social communities quickly.

FEEDBACK

Help us improve Razer Synapse by giving your comments, suggestions, and problems with the software. You can contact us directly using this tab and even earn rewards for reporting bugs.

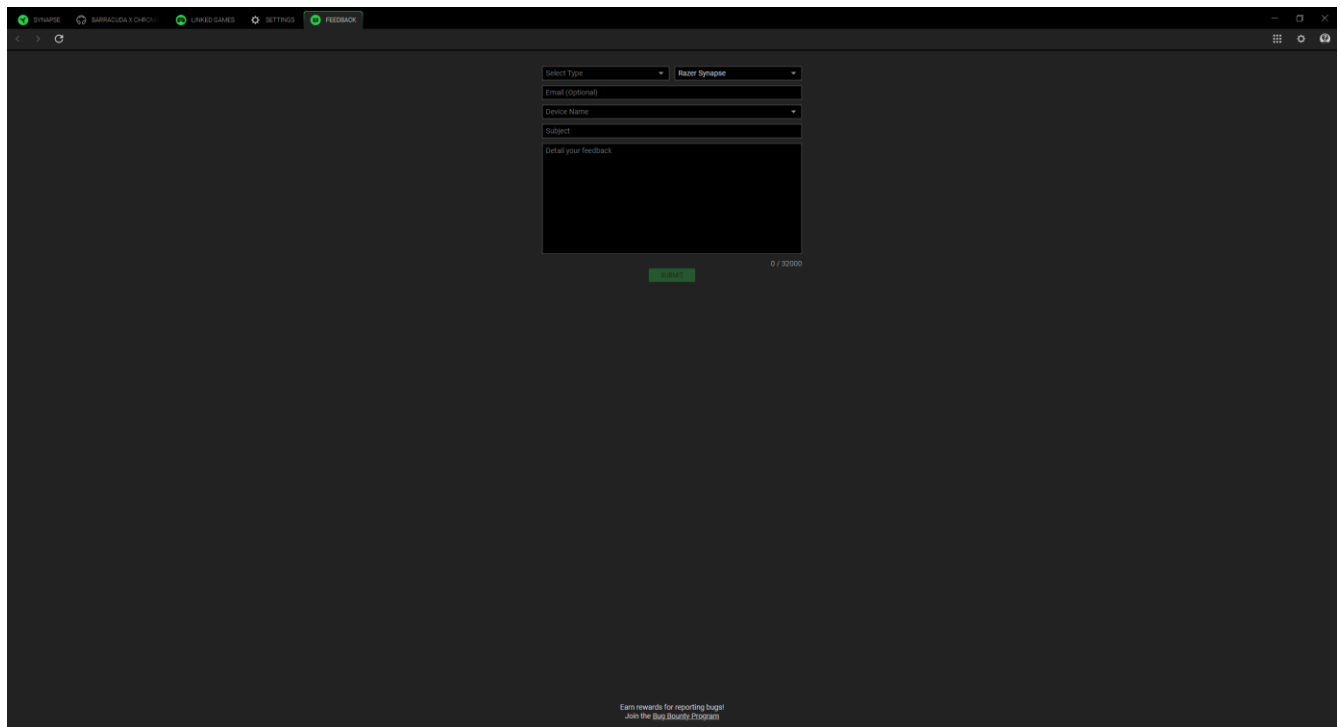

The screenshot shows the Razer Synapse Feedback form interface. At the top, there is a navigation bar with the following items: SYNAPSE, RAZERCCDA Y CHRO..., LINKED GAMES, SETTINGS, and FEEDBACK. The main form area contains the following fields:

- Select Type: Razer Synapse
- Email (Optional):
- Device Name:
- Subject:
- Detail your feedback:

At the bottom right of the form, there is a character count: 0 / 50000. Below the form, there is a green button labeled "Submit". At the very bottom of the page, there is a small text link: "Earn rewards for reporting bugs! Join the Bug Bounty Program".

8. SAFETY AND MAINTENANCE

SAFETY GUIDELINES

In order to achieve maximum safety while using your Razer headset, we suggest that you adopt the following guidelines:

Should you have trouble operating the device properly and troubleshooting does not work, unplug the device and contact the Razer hotline or go to support.razer.com for assistance.

Don't take apart the device, and don't attempt to operate it under abnormal current loads. Doing so will void your warranty.

Keep the device away from liquid, humidity, or moisture. Operate the device only within the specific temperature range of 0°C (32°F) to 40°C (104°F). Should the temperature exceed this range, unplug and/or switch off the device to stabilize the temperature to an optimal level.

We recommend stretching your Razer headset gently apart before placing them over your head to minimize headband stress. However, please avoid overstretching the headset beyond its technical limits.

The device isolates external ambient sounds even at low volumes, resulting in lowered awareness of your external surroundings. Please remove the device when engaging in activities requiring active awareness of your surroundings.

Listening to excessively loud volumes over extended periods can damage your hearing. Furthermore, legislation of certain countries permits a maximum sound level of 86dB to affect your hearing for 8 hours a day. We, therefore, recommend that you reduce the volume to a comfortable level when listening for prolonged periods. Please, take good care of your hearing.

MAINTENANCE AND USE

Your Razer headset requires minimum maintenance to keep it in optimum condition. Once a month, we recommend you clean the device using a soft cloth or cotton swab to prevent dirt buildup. Don't use soap or harsh cleaning agents.

9. LEGALESE

COPYRIGHT AND INTELLECTUAL PROPERTY INFORMATION

©2024 Razer Inc. All rights reserved. Razer, the triple-headed snake logo, Razer logo, and “For Gamers. By Gamers.”, are trademarks or registered trademarks of Razer Inc. and/or affiliated companies in the United States or other countries. All other trademarks are the property of their respective owners.

Copyright © 2003-2023 by Bluetooth SIG, Inc. The Bluetooth® word mark and logos are registered trademarks owned by Bluetooth SIG, Inc.

THX and the THX logo are trademarks of THX Ltd., registered in the U.S. and other countries.

Windows and the Windows logo are trademarks or registered trademarks of the Microsoft group of companies.

Razer Inc. (“Razer”) may have copyright, trademarks, trade secrets, patents, patent applications, or other intellectual property rights (whether registered or unregistered) concerning the product in this guide. Furnishing of this guide does not give you a license to any such copyright, trademark, patent or other intellectual property right. The Razer Barracuda X Chroma (the “Product”) may differ from pictures whether on packaging or otherwise. Razer assumes no responsibility for such differences or for any errors that may appear. Information contained herein is subject to change without notice.

LIMITED PRODUCT WARRANTY

For the latest and current terms of the Limited Product Warranty, please visit [razer.com/warranty](https://www.razer.com/warranty).

LIMITATION OF LIABILITY

Razer shall in no event be liable for any lost profits, loss of information or data, special, incidental, indirect, punitive or consequential or incidental damages, arising in any way out of distribution of, sale of, resale of, use of, or inability to use the Product. In no event shall Razer’s liability exceed the retail purchase price of the Product.

GENERAL

These terms shall be governed by and construed under the laws of the jurisdiction in which the Product was purchased. If any term herein is held to be invalid or unenforceable, then such term (in

so far as it is invalid or unenforceable) shall be given no effect and deemed to be excluded without invalidating any of the remaining terms. Razer reserves the right to amend any term at any time without notice.